

Plan 20m² (4m x 5m) ouverture type bar.

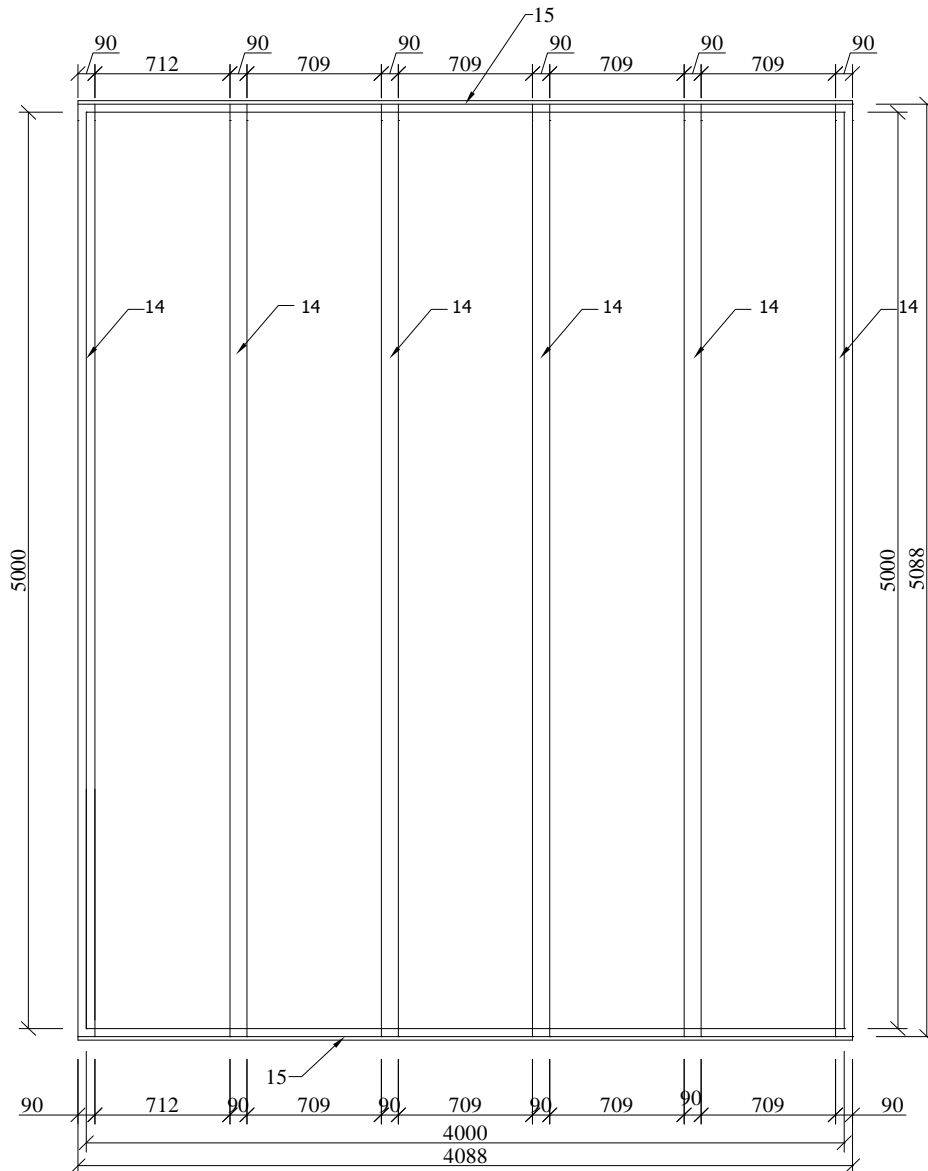

20m² (4m x 5m) en 44mm avec ouverture type bar.

**PLANS
Soubassement.**

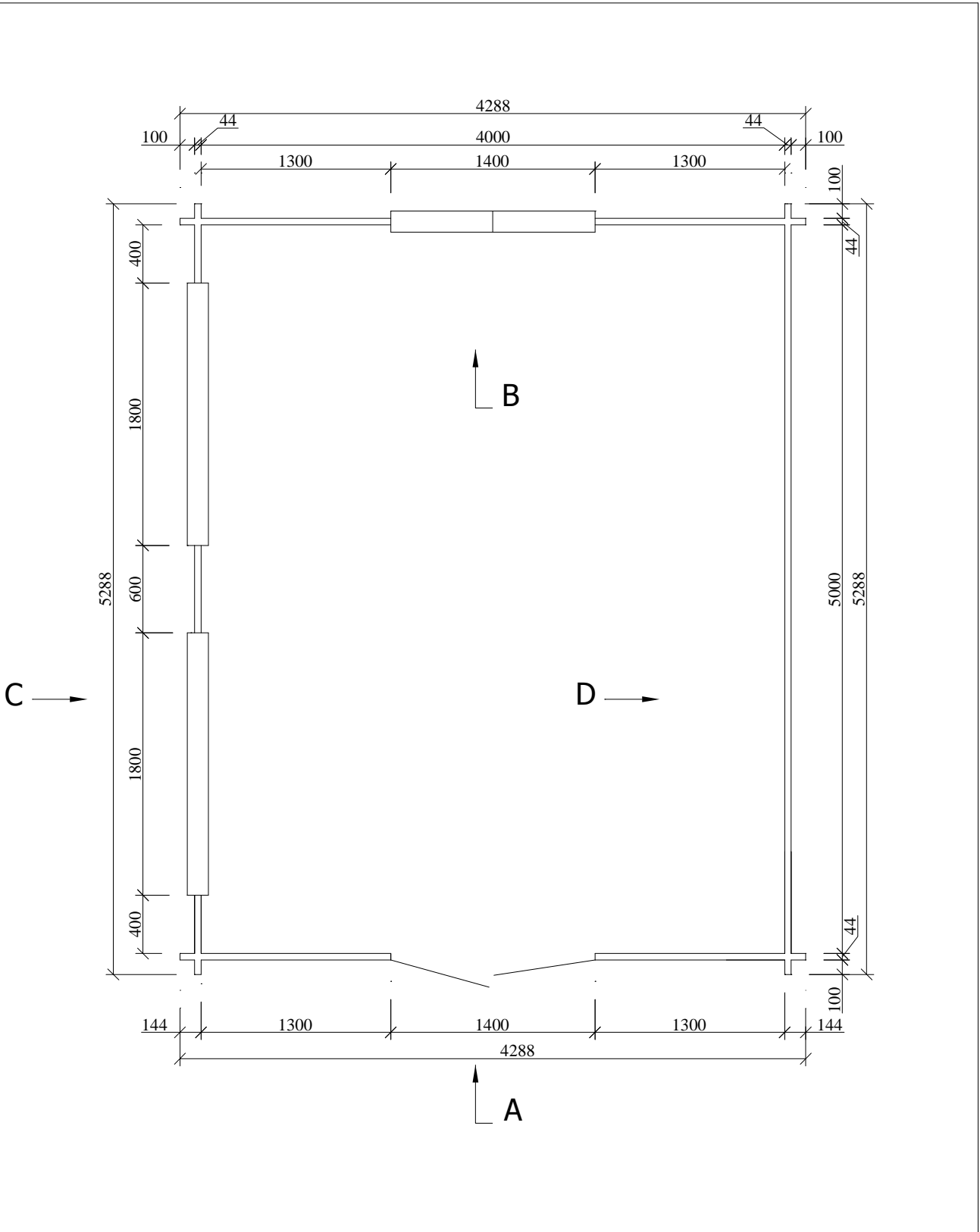

20m² (4mx5m) en 44mm avec ouverture type bar.

PLANS

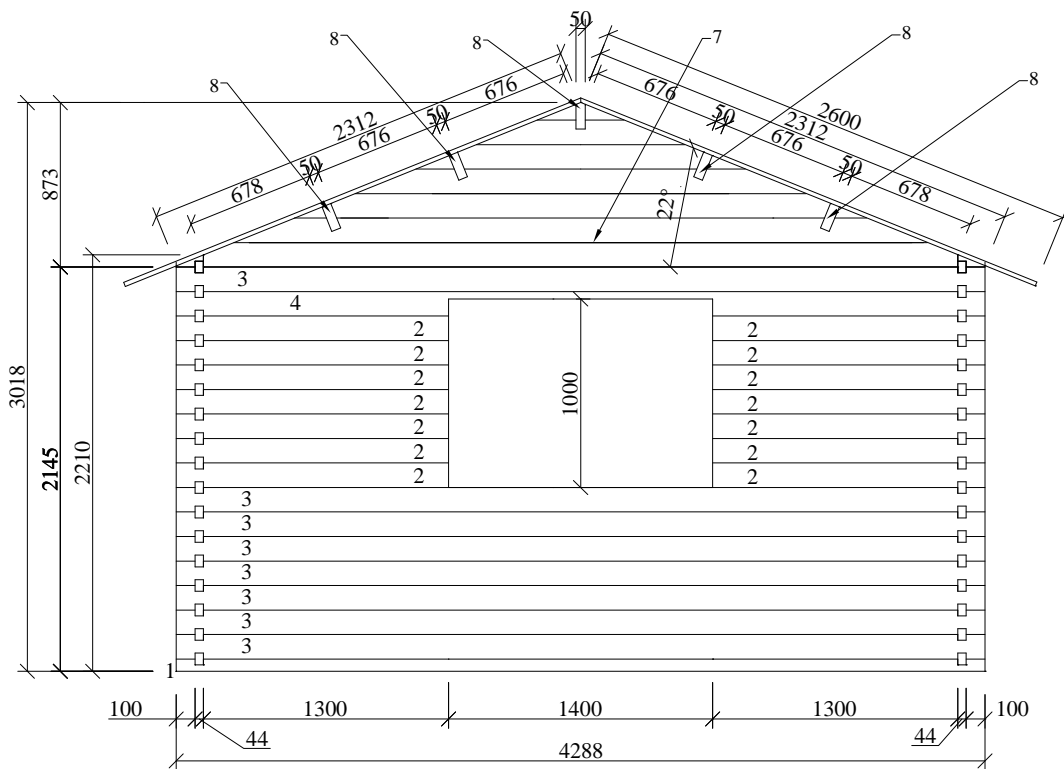
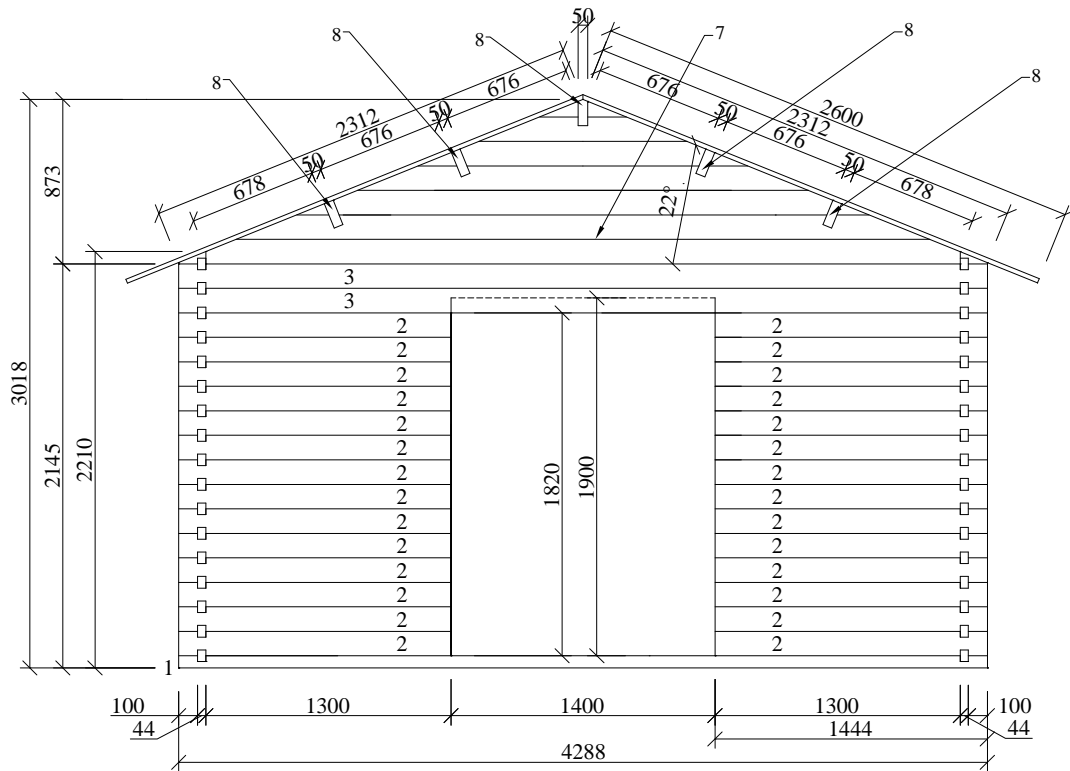

20m² (4mx5m) en 44mm avec ouverture type bar.

Murs A et B

Poz. 1

2 vnt.

(siena A,B)

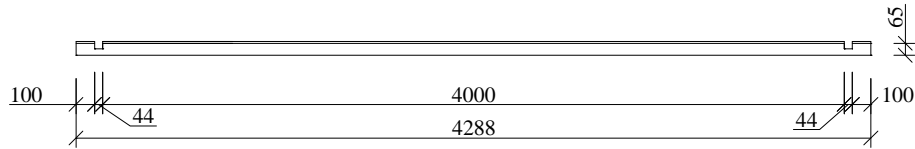

Poz. 2

42 vnt.

(siena A;D)

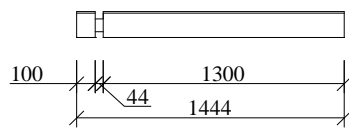

Poz. 3

10 vnt.

(siena A,B)

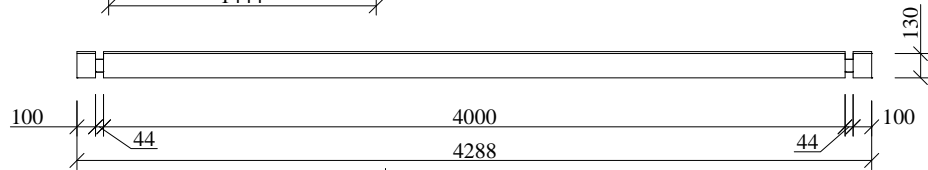

Poz. 4

1 vnt.

(siena B)

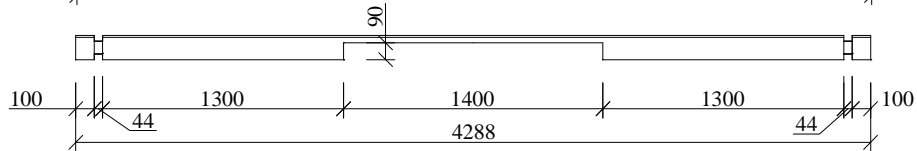

Poz. 5

16 vnt.

(siena C)

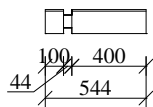

Poz. 6

8 vnt.

(siena C)

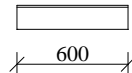

Poz. 7

2 vnt.

(siena A,B)

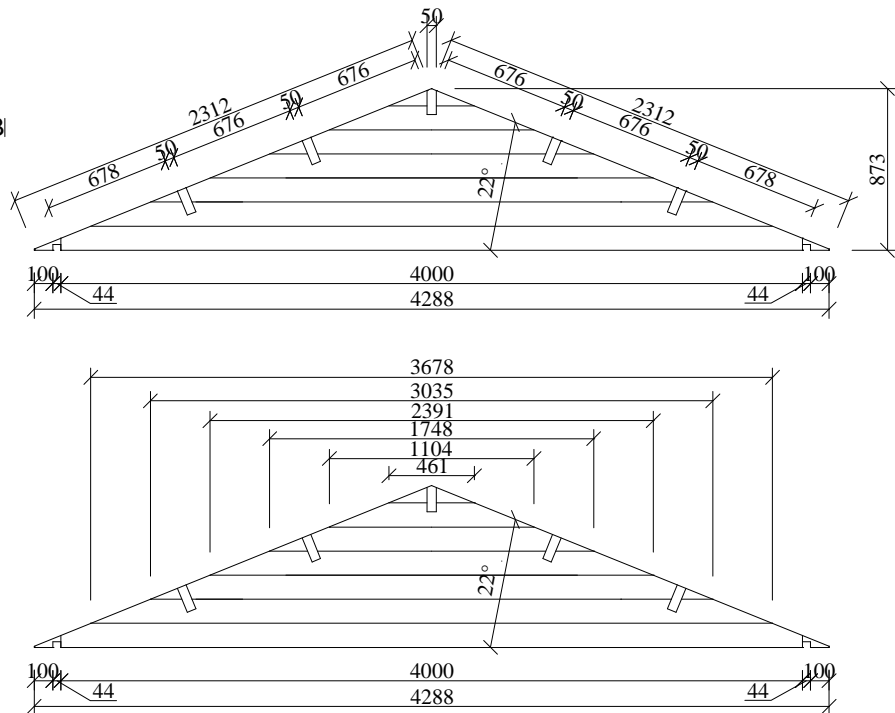

20m² (4mx5m) en 44mm avec ouverture type bar.

Détails

Poz. 8
1+4 vnt.
 (Gegnes)

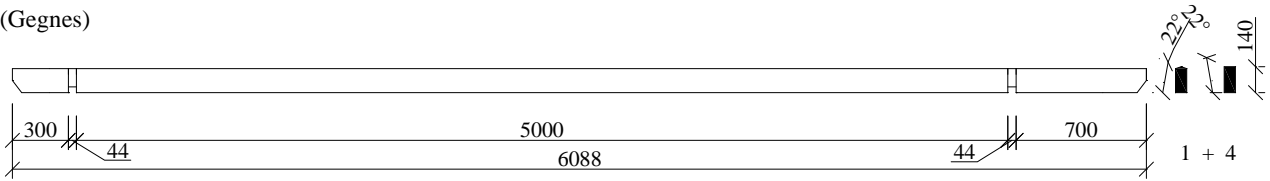

Poz. 9
20 vnt.

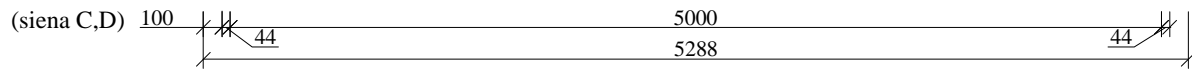

Poz. 10
1 vnt.

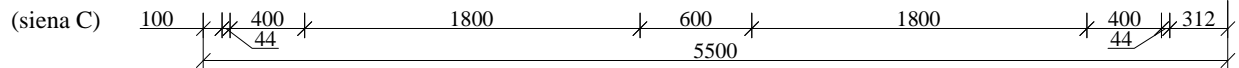

Poz. 11
2 vnt.

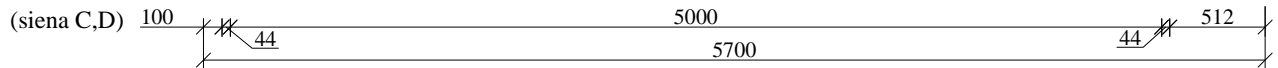

Poz. 12
1+1 vnt.

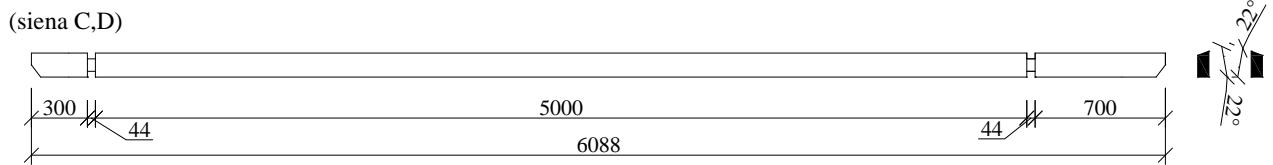

Poz. 13
1 vnt.

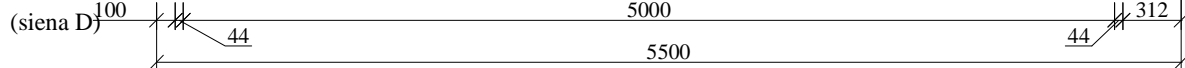

20m² (4mx5m) en 44mm avec ouverture type bar.

Détails