

Joint de sol

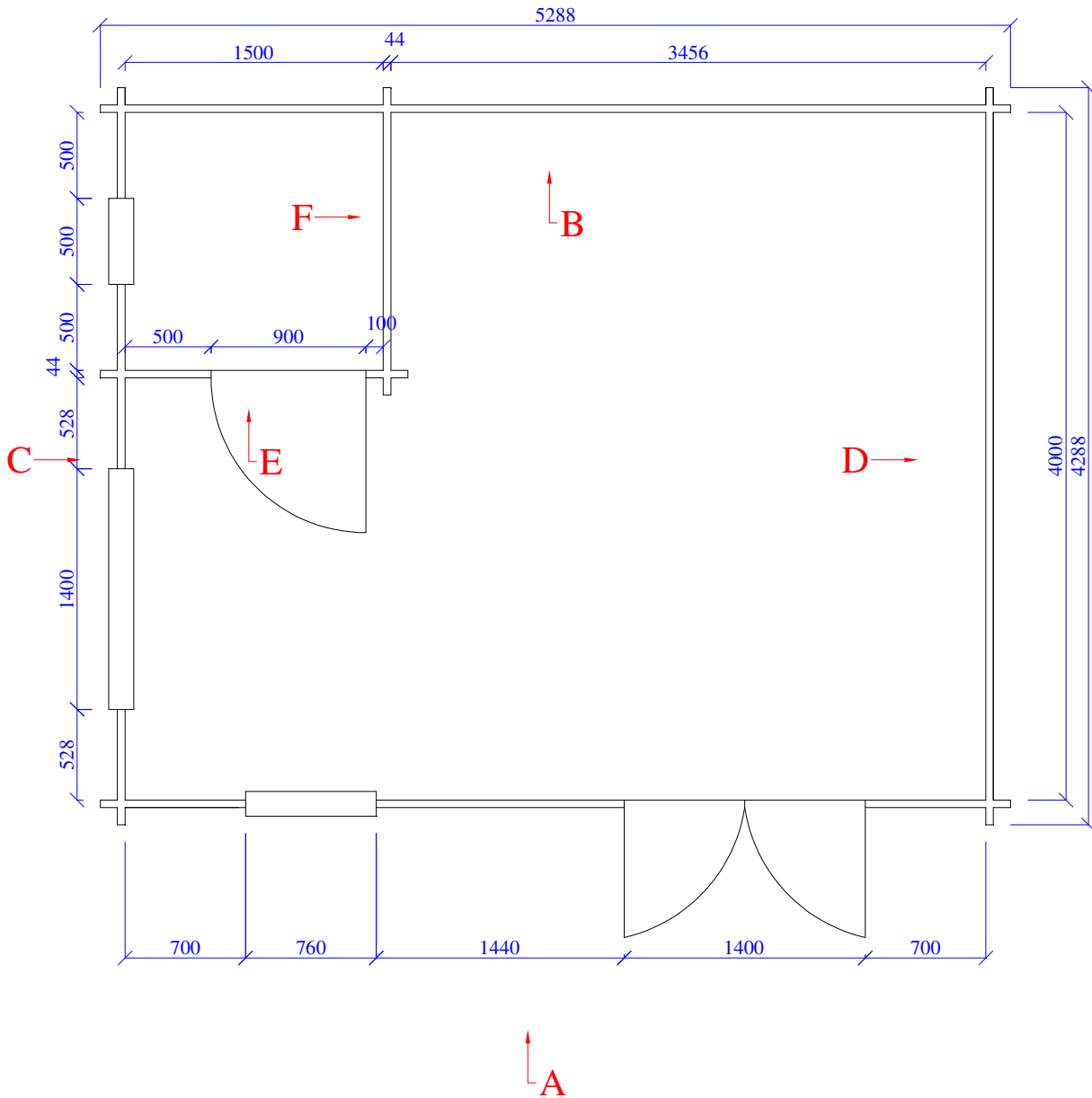

**Plan**

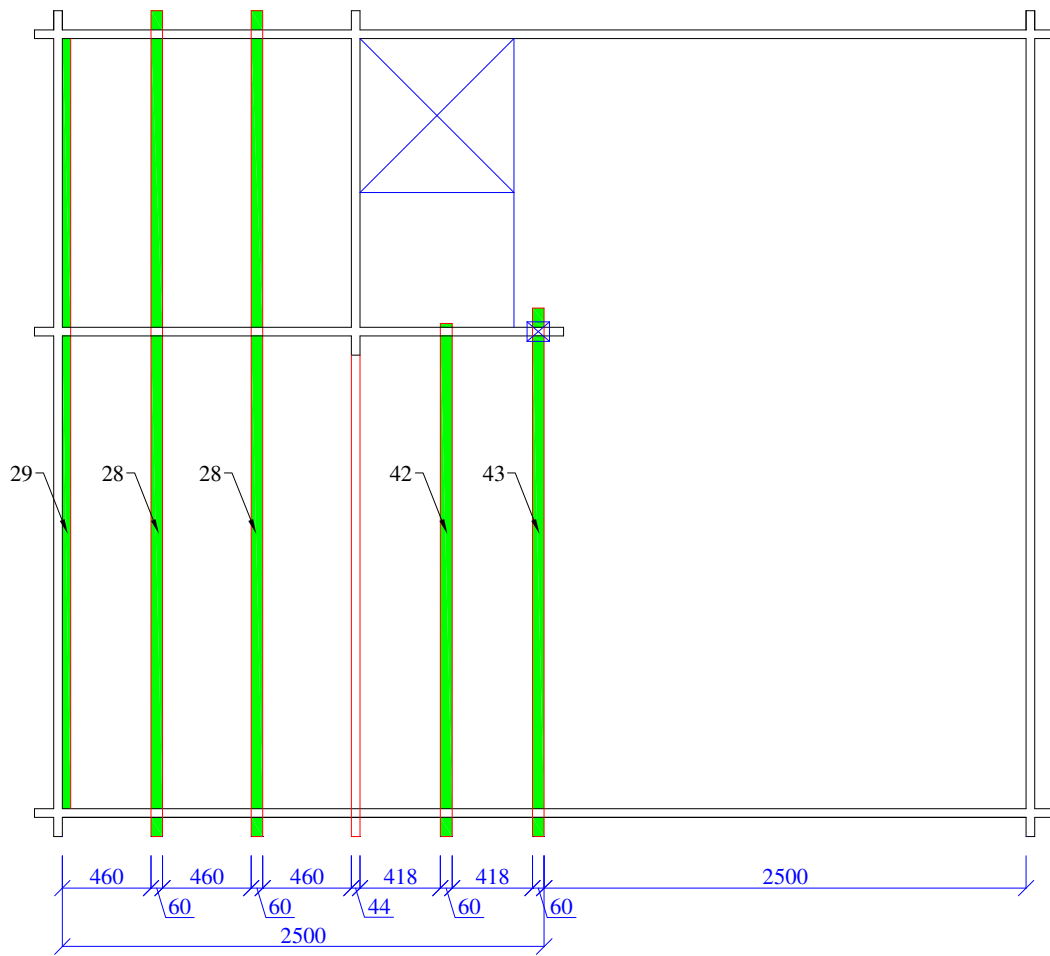

Solives de l'etage

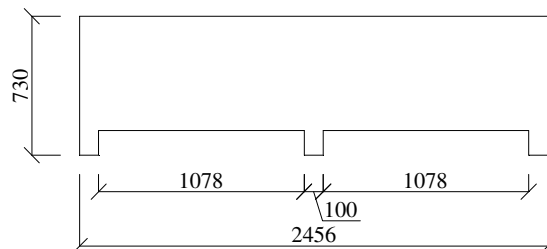
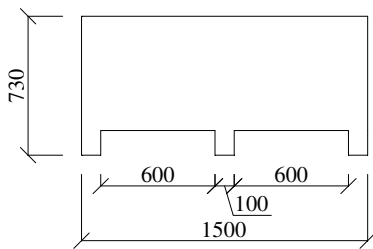
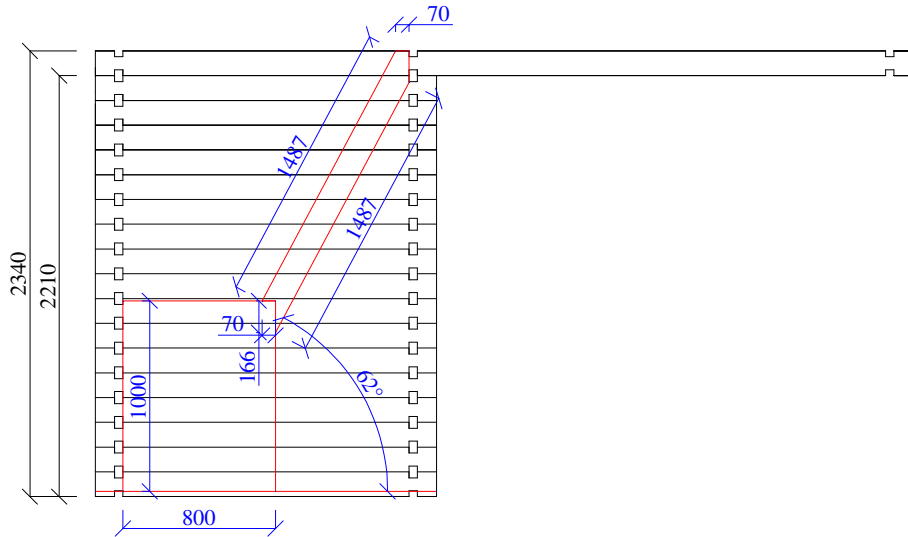

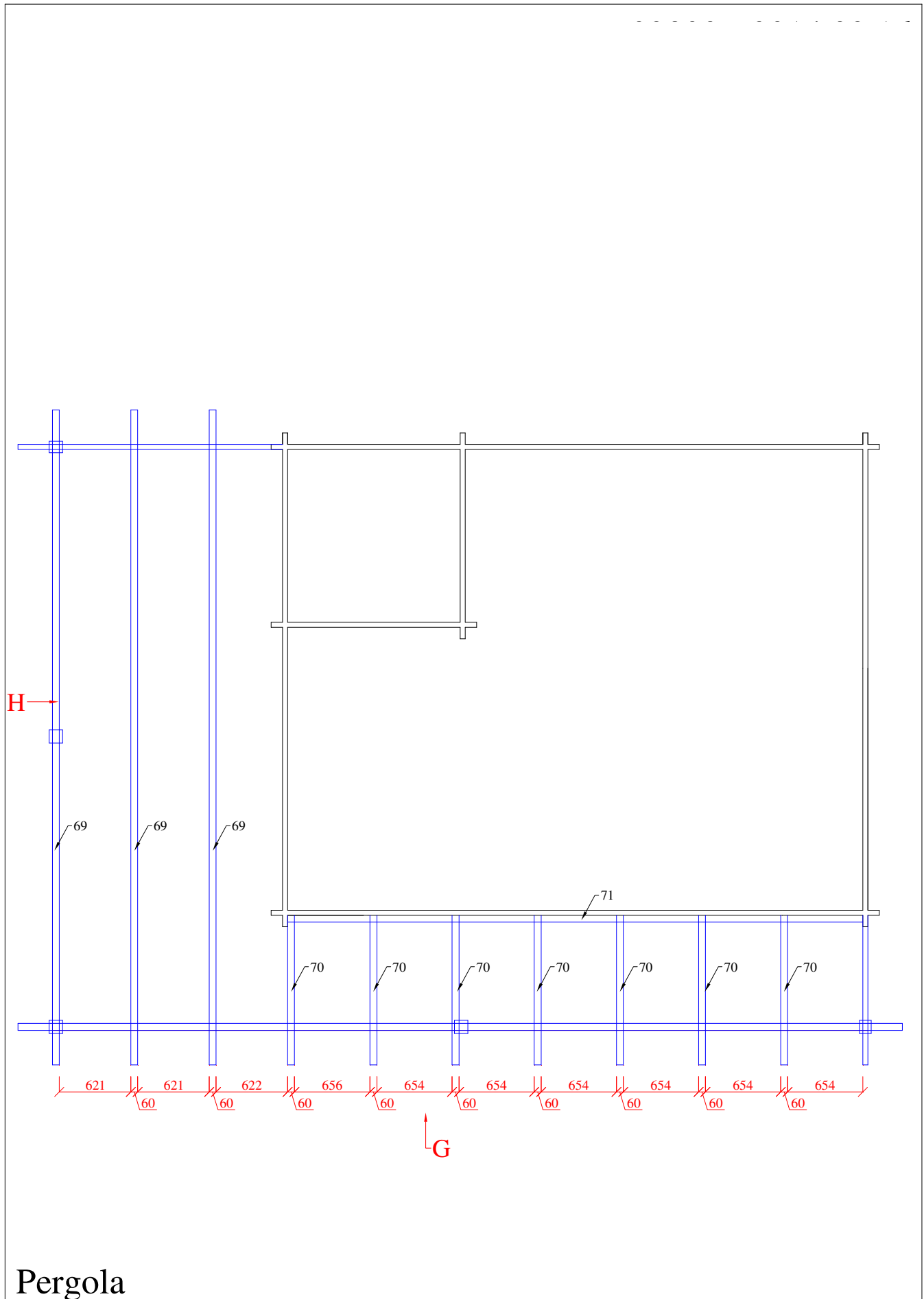

**Pergola**

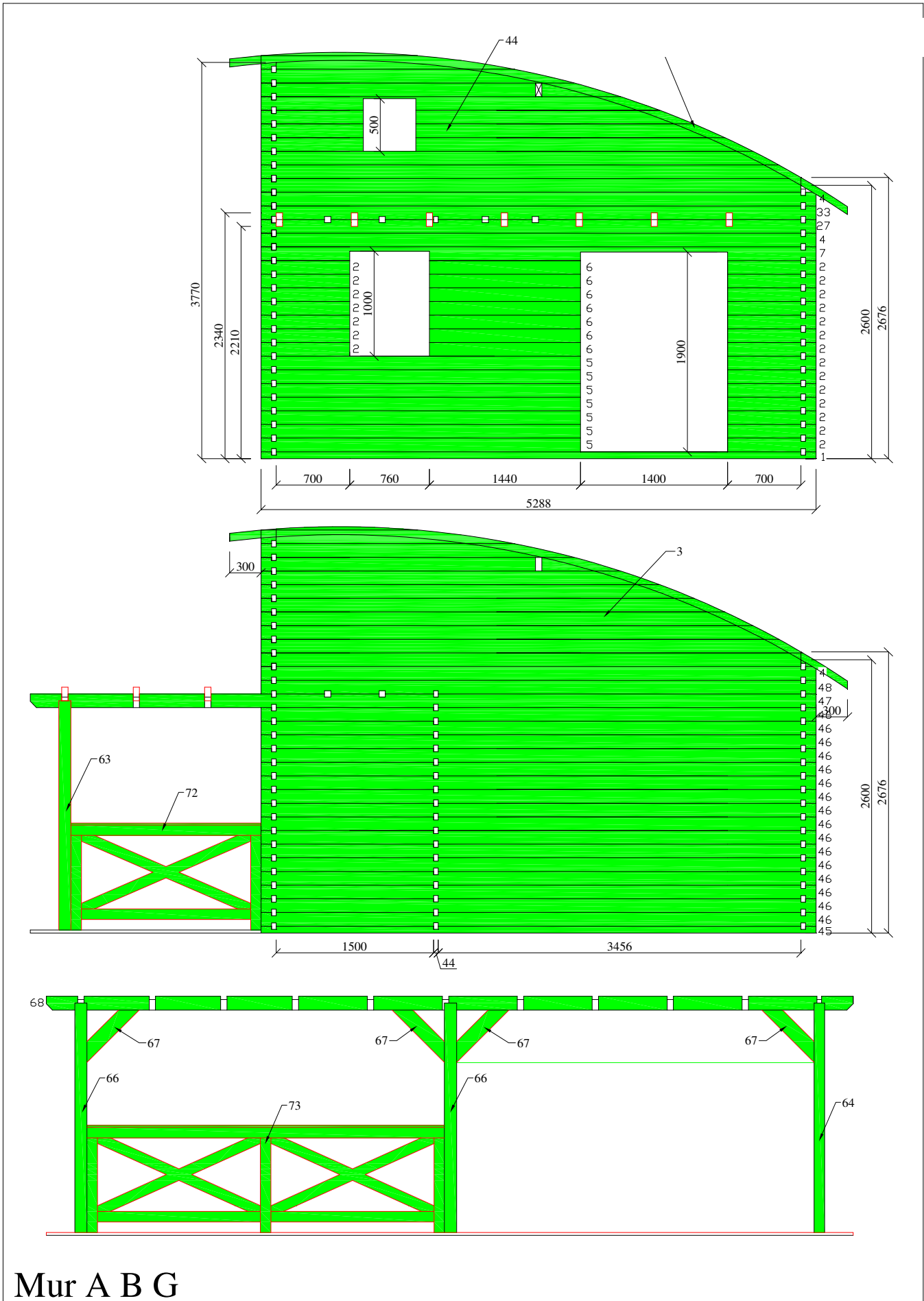

Mur A B G

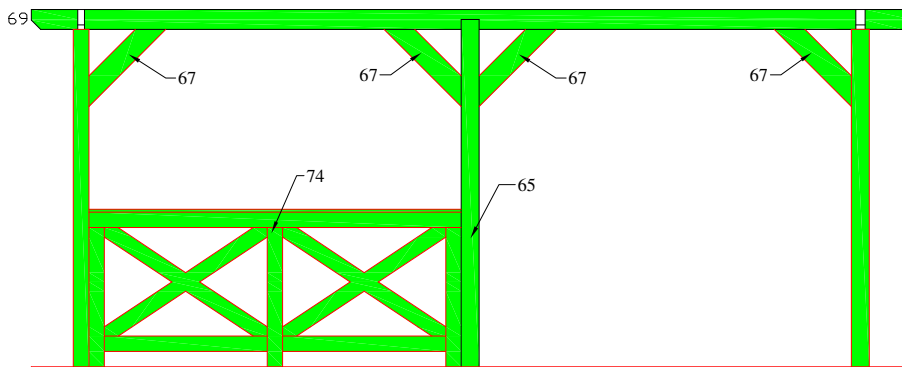
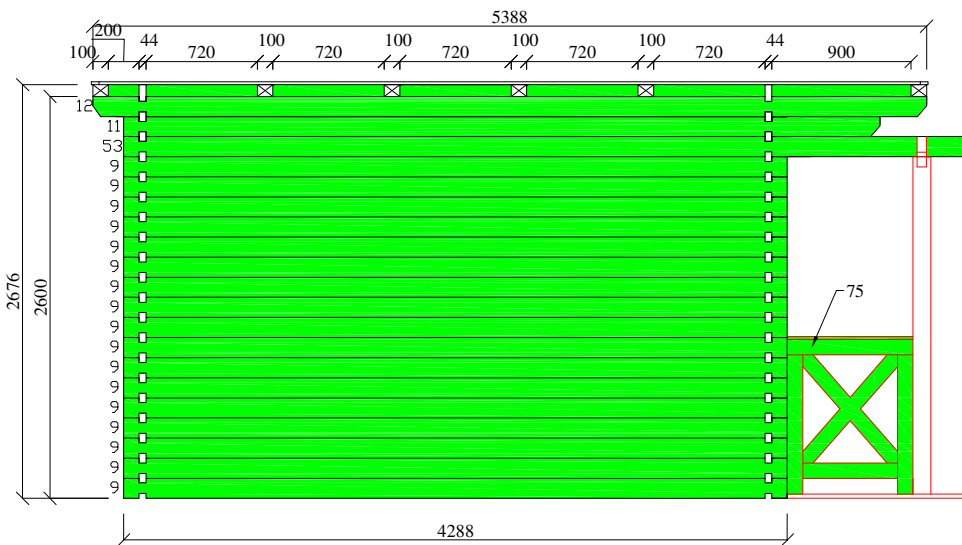
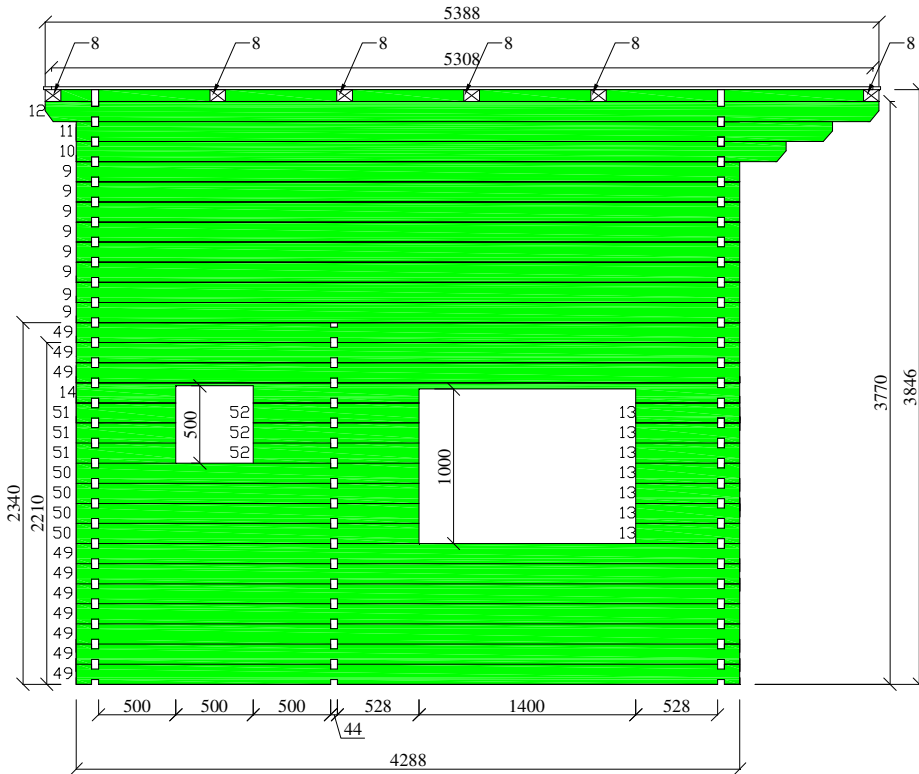

Mur C D H

