

**JOINT DE SOL**

**NB6040(60)**

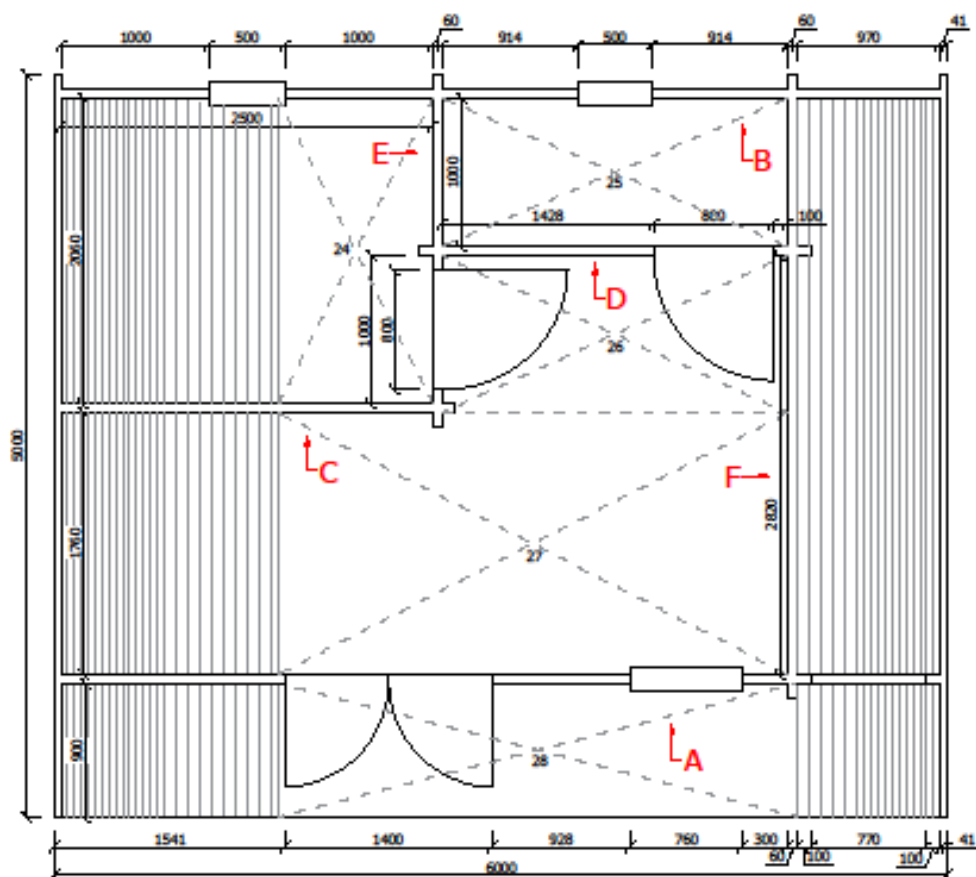

PLAN

NB6040(60)

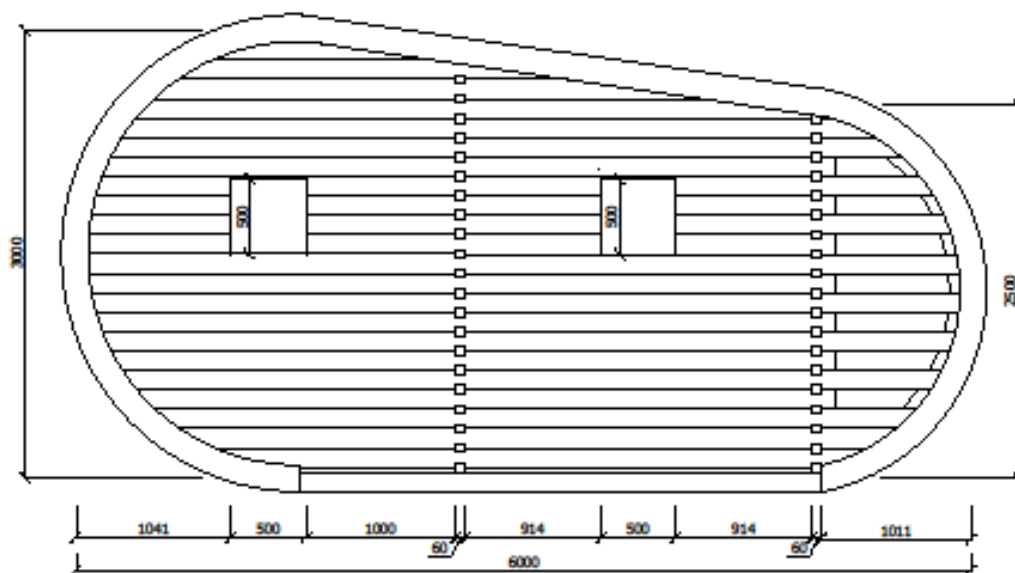
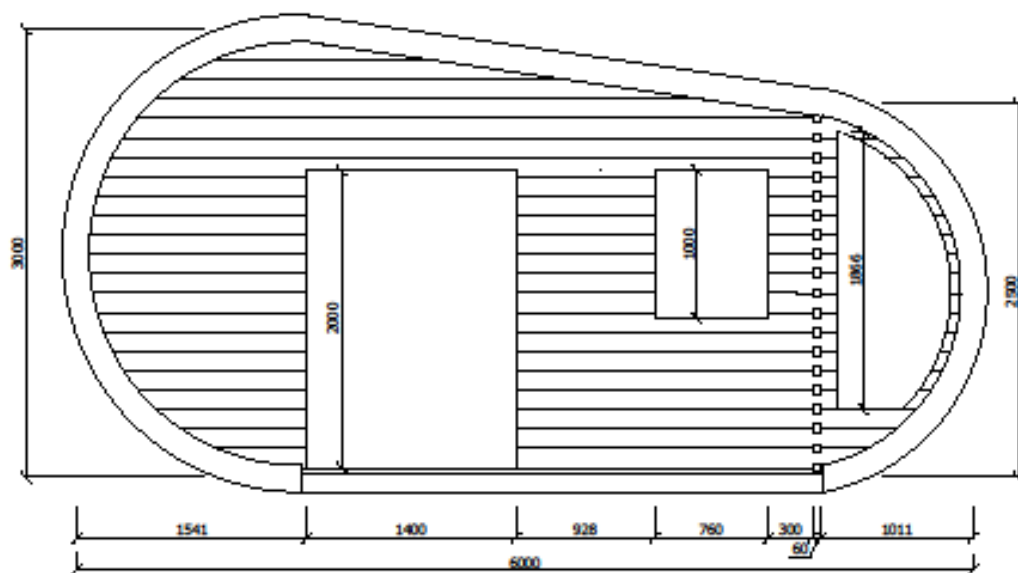

MURS A et B

NB6040(60)

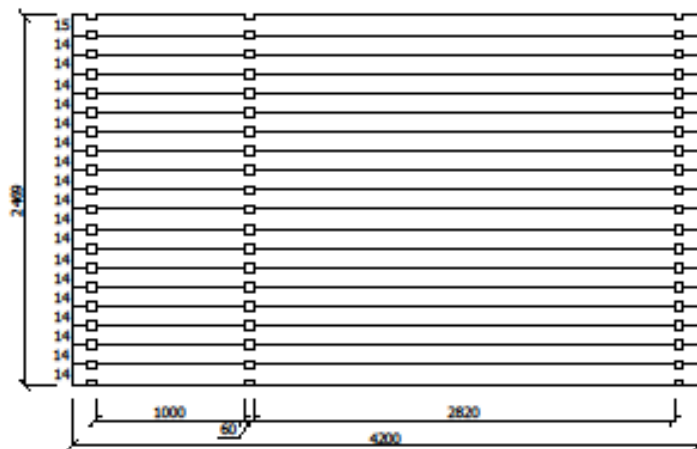
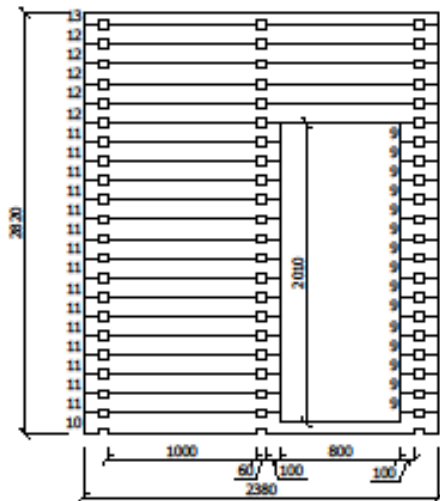
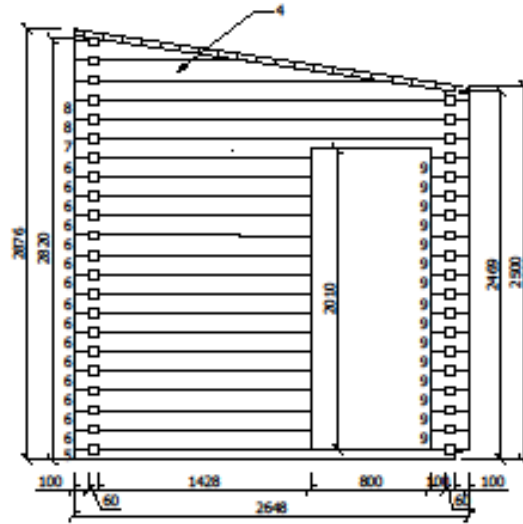
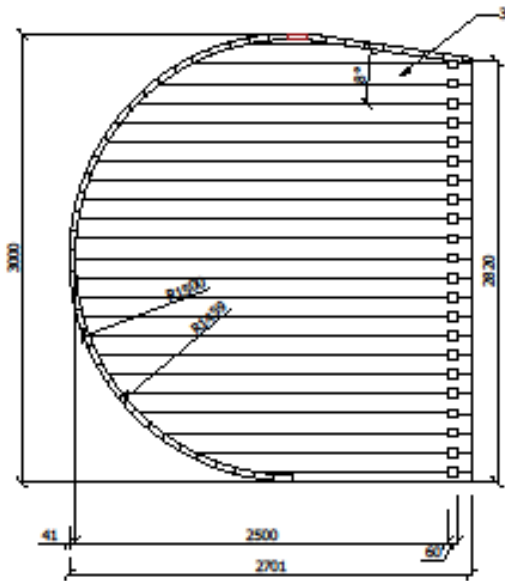

MURS C, D, E et F

NB6040(60)

*l'Européenne*  
**de Chalets**  
*www.euro-chalet.fr*

